

Datasheet for #sb260

Recommendations:

Please read the starter kit user manual (at least installation chapter 5), if available, and have a look at the FAQ at <http://www.alpeslasers.ch/alfaq.pdf>

WARNING: Operating the laser with longer pulses, shorter period, or higher voltage or current than specified in this document may cause damage and will result in loss of warranty, unless agreed upon with Alpes Lasers!

WARNING: Beware of the polarity of the laser. This laser has to be powered with negative bias on the laser contact (= bonding pad, corresponding to the label "laser" on the LLH) and the positive bias on the base contact (= submount, corresponding to the label "base" on the LLH).

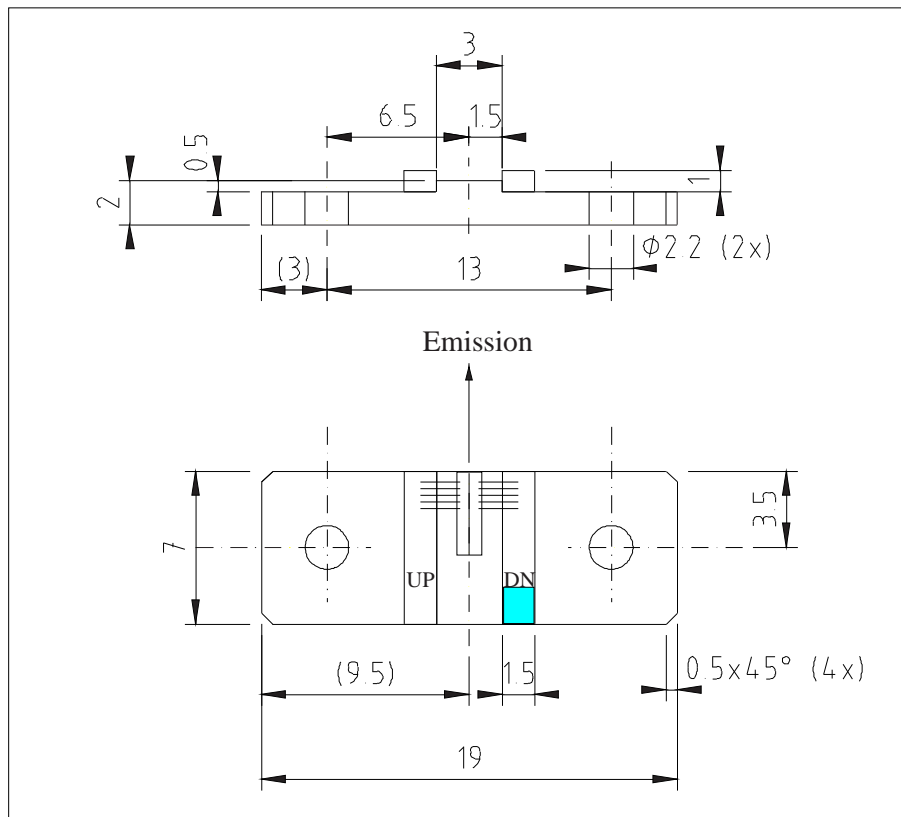

Figure 1: Support mounting for #sb260 (please note that the laser is connected to the DN pad drawn in blue)

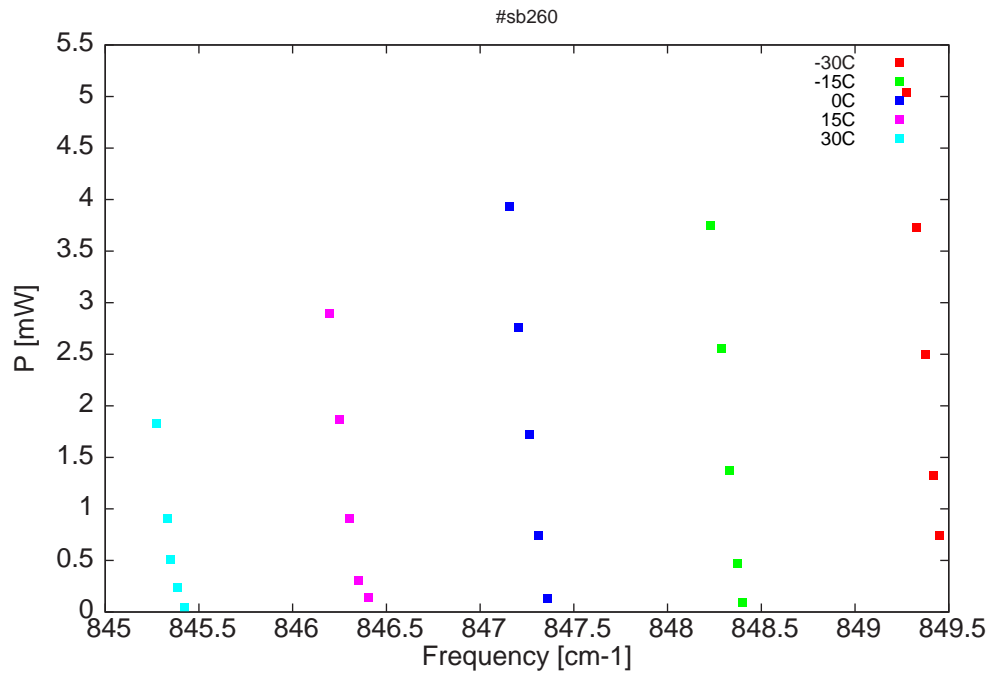

Figure 2: Output power as a function of the singlemode emission frequencies and temperatures

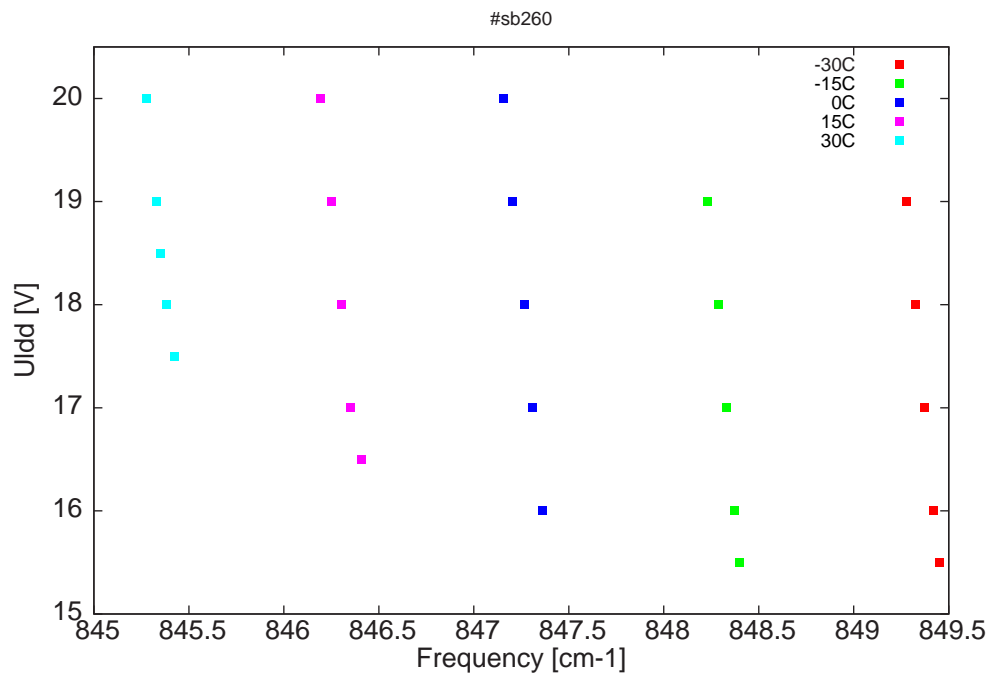

Figure 3: DC voltage fed to LDD (U_{ldd}) as a function of the singlemode emission frequencies and temperatures

λ [nm]	ν [cm ⁻¹]	P[mW]	Temp[°C]	U_{LDD} [V]	I_{pulse} [A]
11772.3	849.4	0.7	-30	15.5	4.46
11772.7	849.4	1.3	-30	16	4.7
11773.4	849.4	2.5	-30	17	5.11
11774	849.3	3.7	-30	18	5.59
11774.7	849.3	5	-30	19	6.02
11786.9	848.4	0.1	-15	15.5	4.52
11787.3	848.4	0.5	-15	16	4.74
11787.8	848.3	1.4	-15	17	5.19
11788.5	848.3	2.6	-15	18	5.63
11789.2	848.2	3.8	-15	19	6.07
11801.4	847.4	0.1	0	16	4.79
11802	847.3	0.7	0	17	5.22
11802.7	847.3	1.7	0	18	5.65
11803.5	847.2	2.8	0	19	6.12
11804.2	847.2	3.9	0	20	6.56
11814.7	846.4	0.1	15	16.5	5.07
11815.4	846.4	0.3	15	17	5.26
11816.1	846.3	0.9	15	18	5.72
11816.9	846.2	1.9	15	19	6.14
11817.6	846.2	2.9	15	20	6.59
11828.4	845.4	0	30	17.5	5.53
11829	845.4	0.2	30	18	5.75
11829.4	845.3	0.5	30	18.5	5.97
11829.7	845.3	0.9	30	19	6.19
11830.5	845.3	1.8	30	20	6.61

Table 1 : singlemode optical output power as function of operating parameters

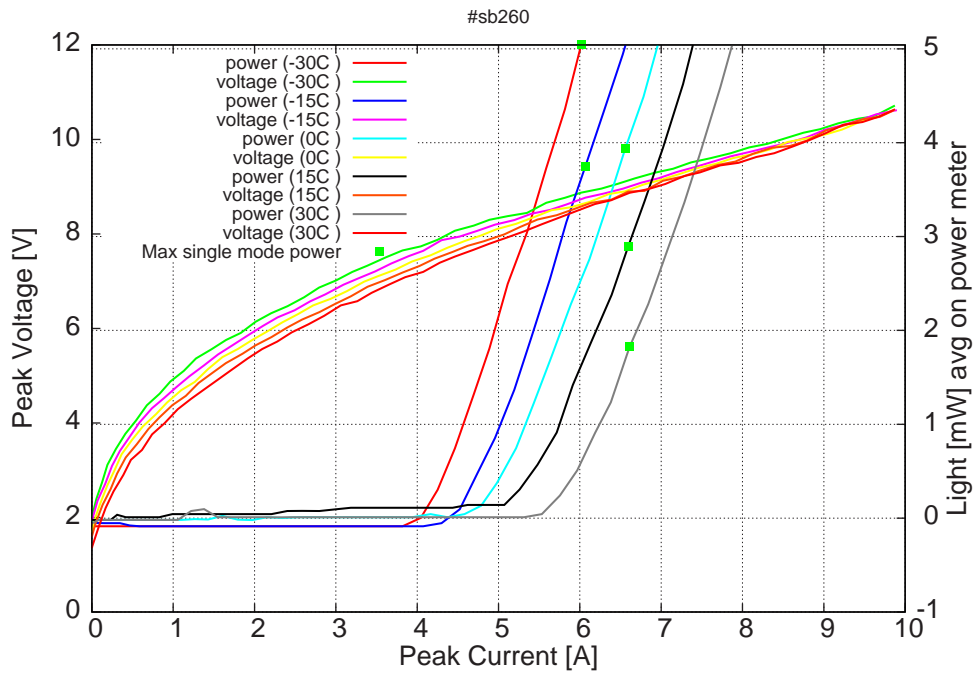

Figure 4: peak voltage and average power vs peak current at 2%dc (the solid squares indicate the maximum singlemode emitted power)

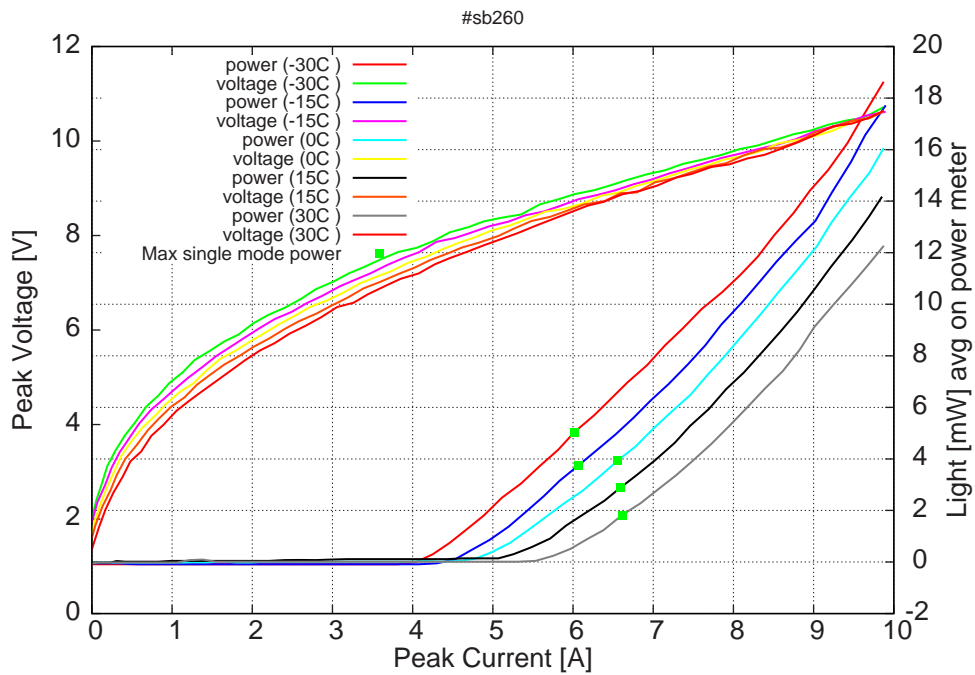

Figure 5: peak voltage and average power vs peak current at 2%dc (including the multi-mode region)

Note: data taken with 50ns pulses, 2.5 μ s period.

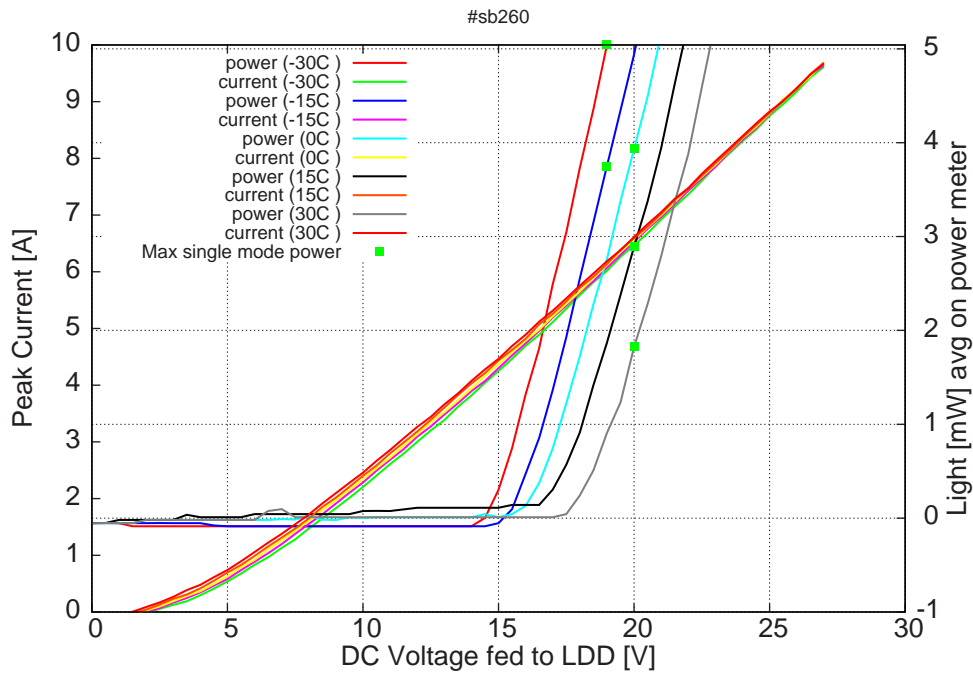

Figure 6: peak current and average power vs LDD voltage at 2%dc (the solid squares indicate the maximum singlemode emitted power)

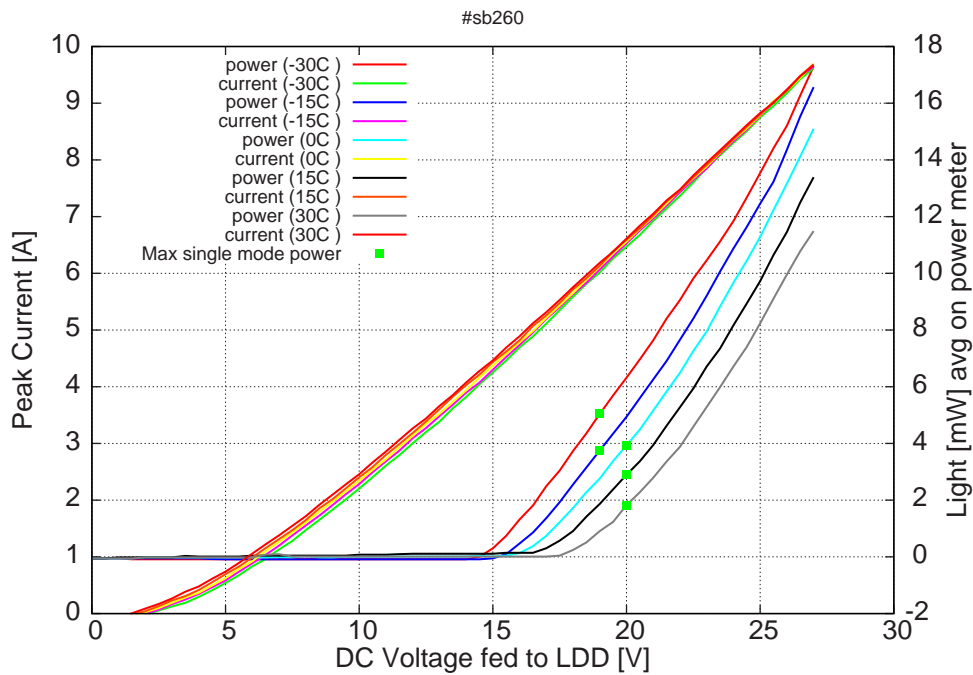

Figure 7: peak current and average power vs LDD voltage at 2%dc (including the multi-mode region)

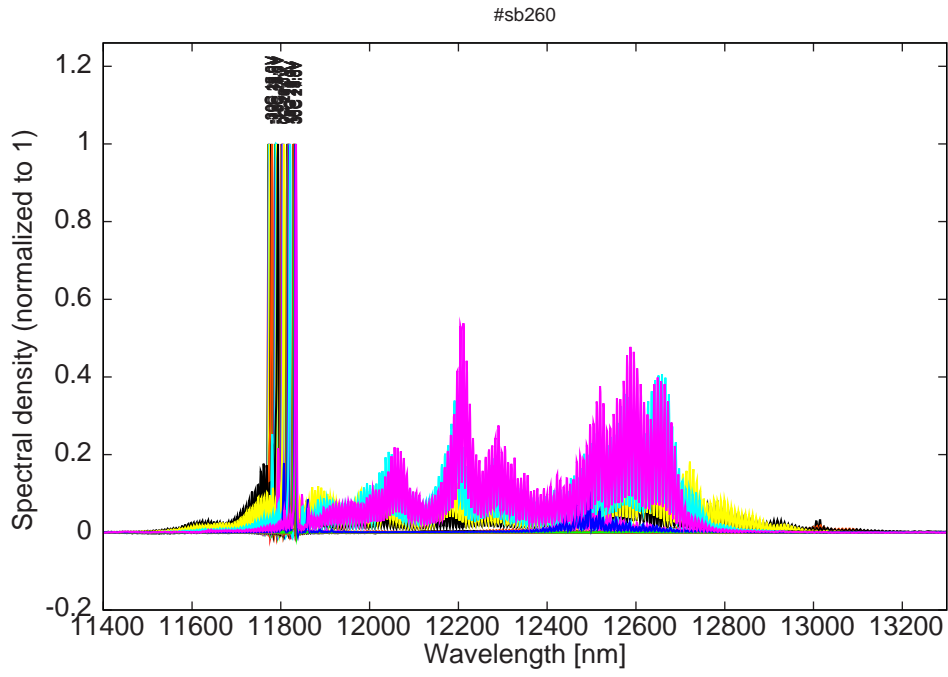

Figure 8: spectra at -30C, -15C, 0C, 15C and 30C at 2%dc for various LDD voltage

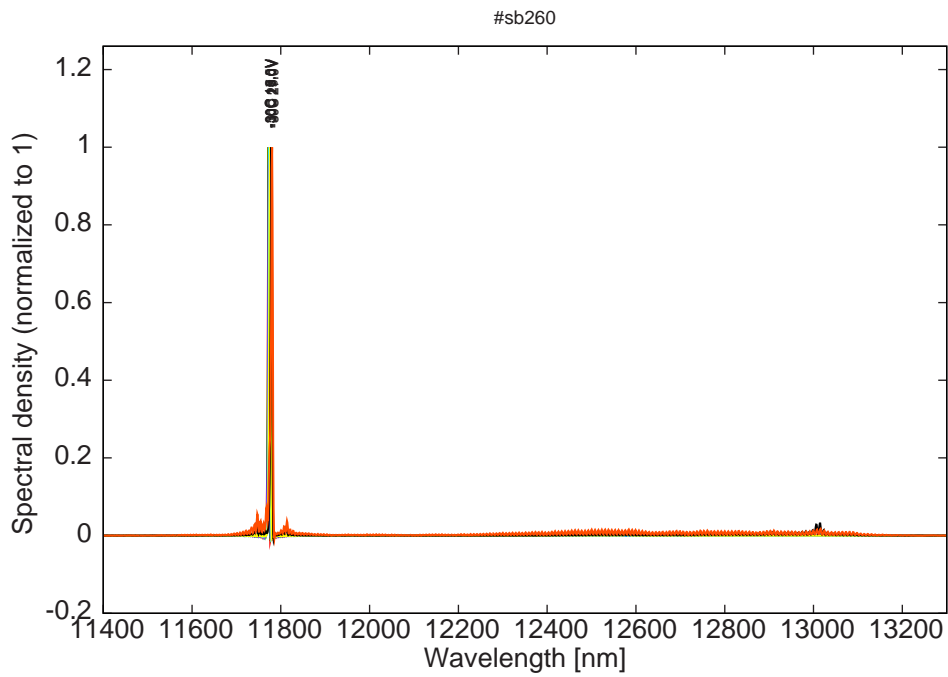

Figure 9: spectra at -30C for various LDD voltage

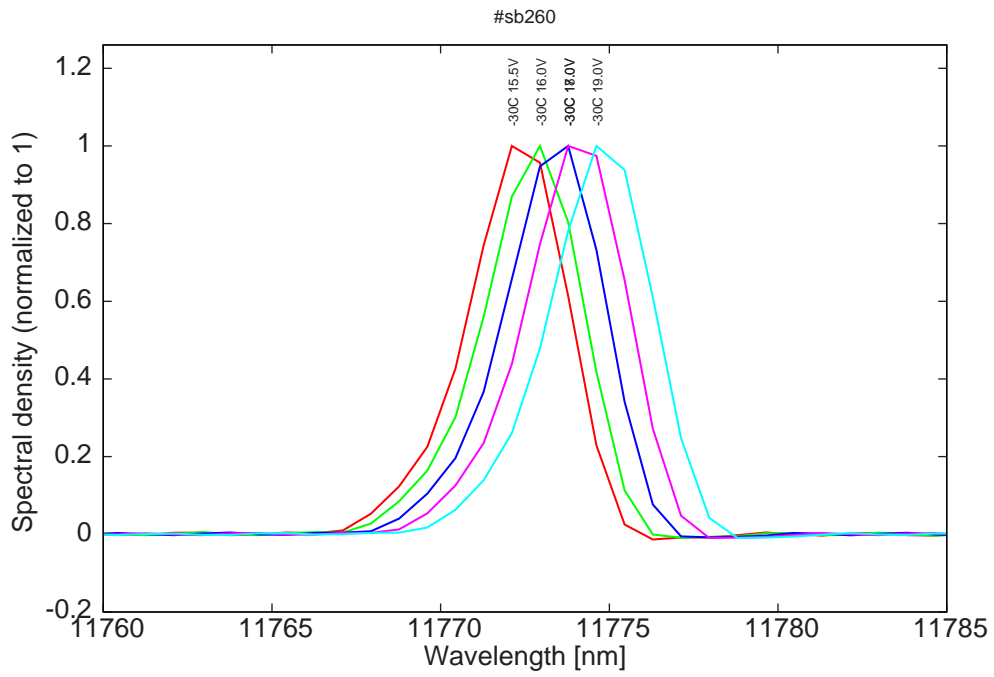

Figure 10: spectra at -30C for various LDD voltage (monomode range)

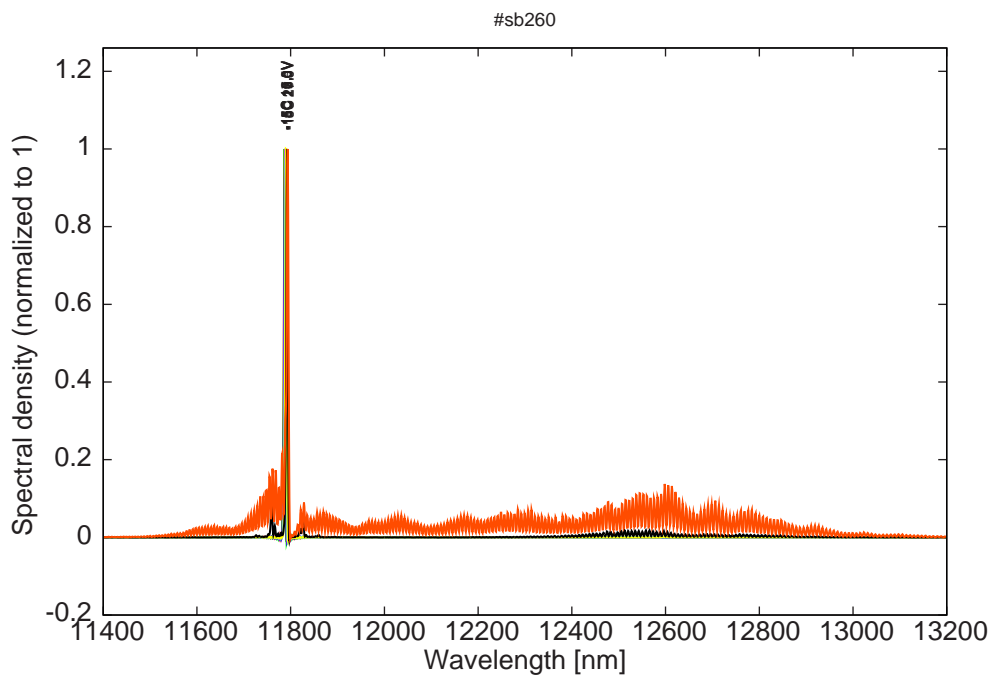

Figure 11: spectra at -15C for various LDD voltage

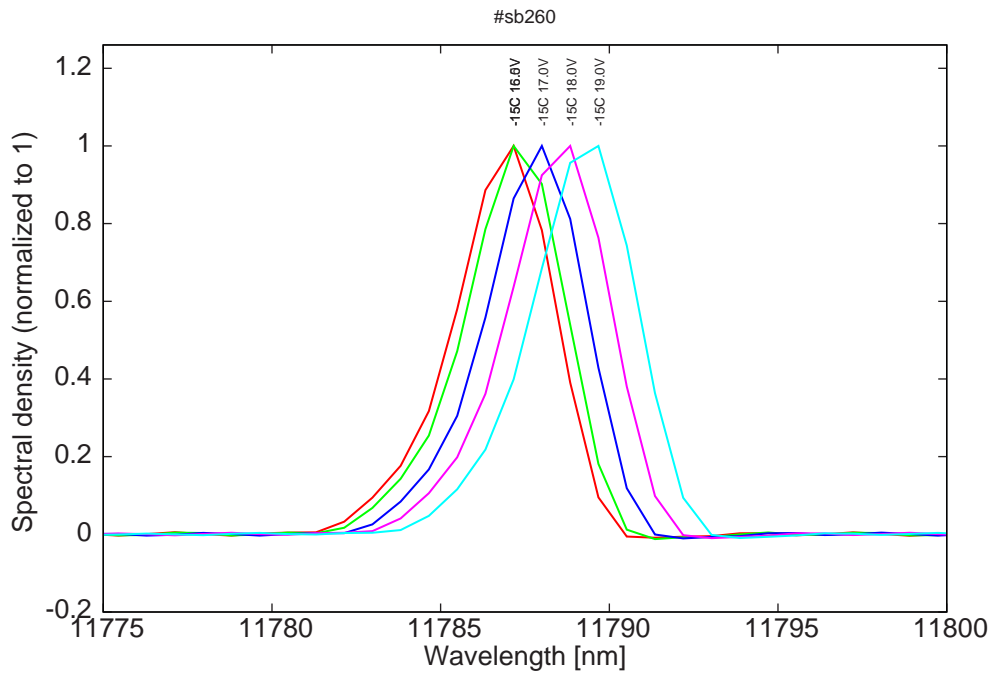

Figure 12: spectra at -15C for various LDD voltage (monomode range)

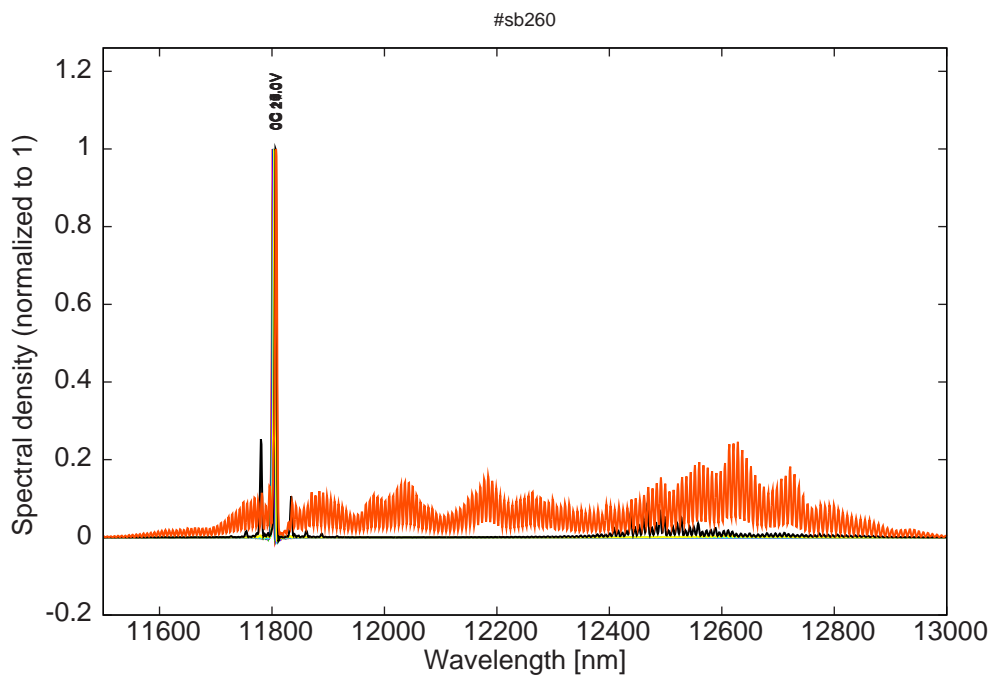

Figure 13: spectra at 0C for various LDD voltage

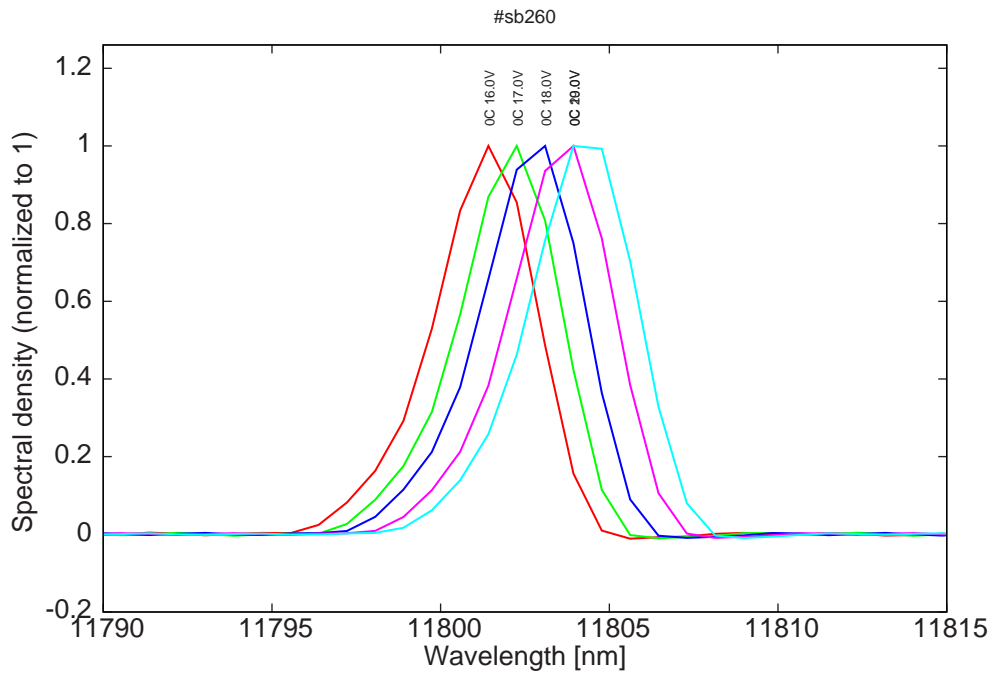

Figure 14: spectra at 0C for various LDD voltage (monomode range)

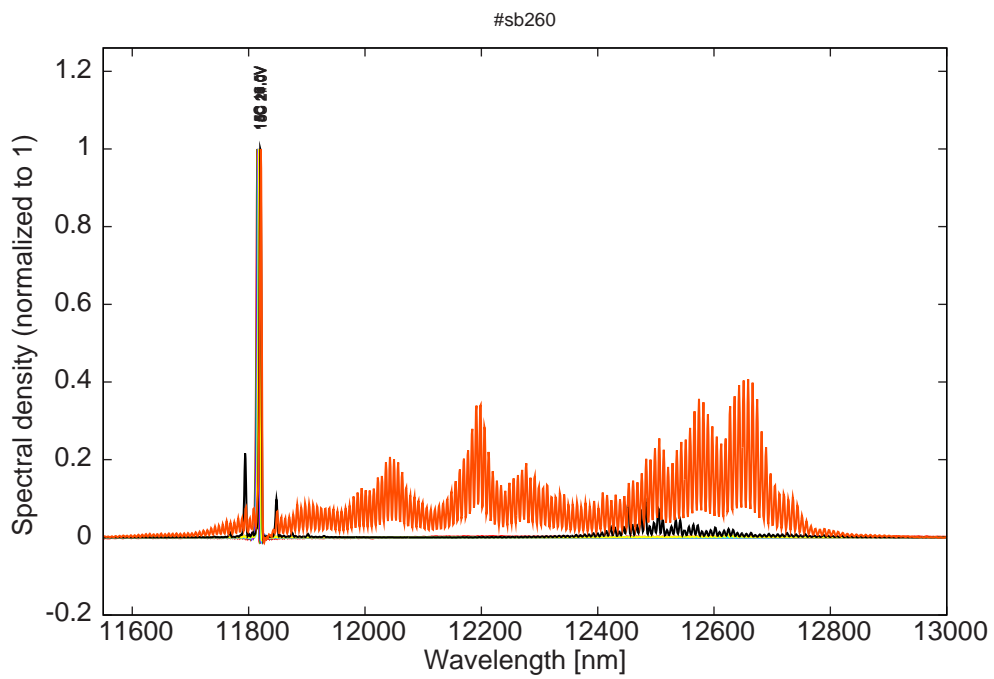

Figure 15: spectra at 15C for various LDD voltage

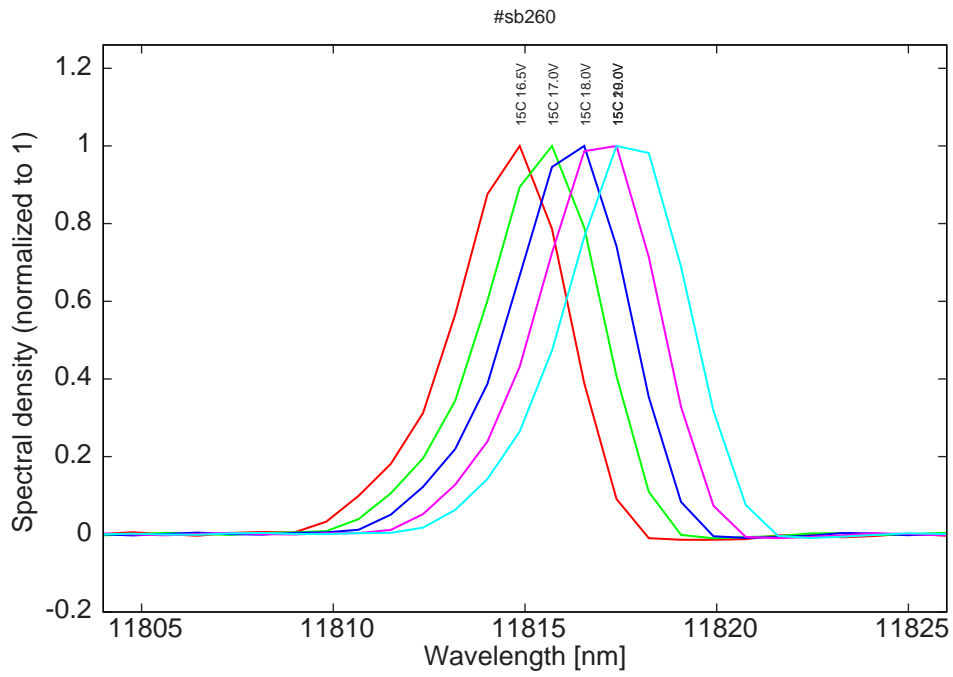

Figure 16: spectra at 15C for various LDD voltage (monomode range)

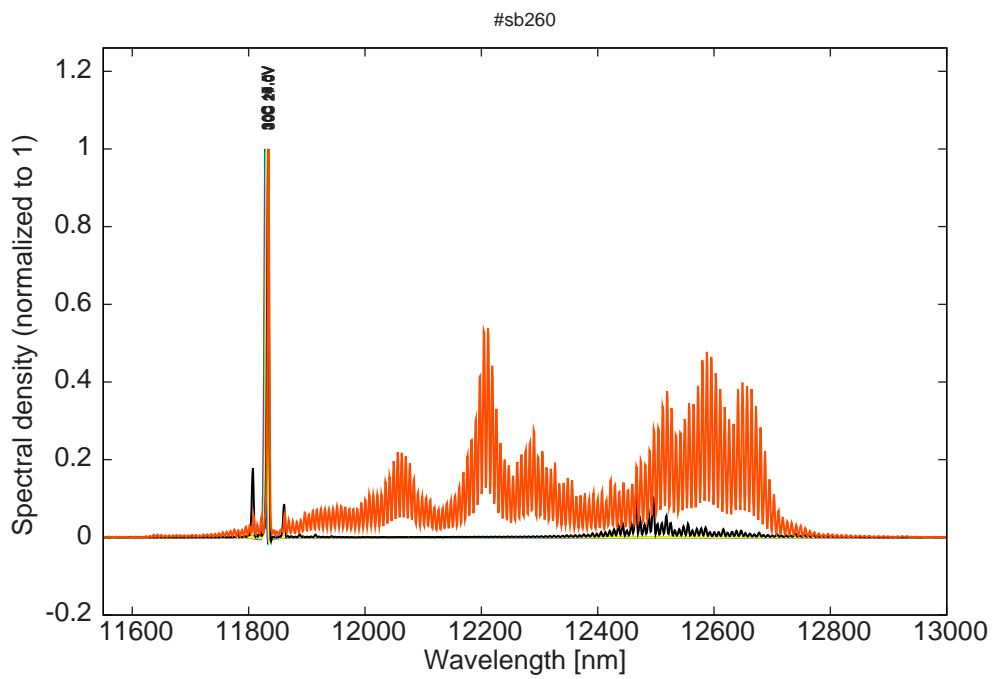

Figure 17: spectra at 30C for various LDD voltage

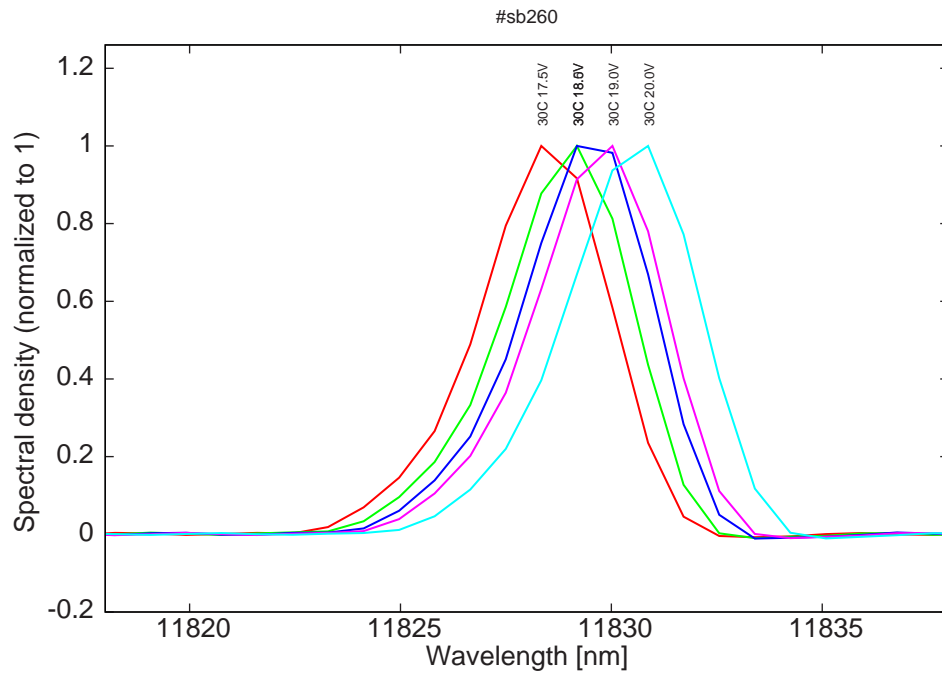

Figure 18: spectra at 30C for various LDD voltage (monomode range)